

# Beyond Boundaries, Closer to Care

Your Complete Telehealth Solution



2024

# Why do you need Kelly?

## Simplified Process

Enjoy a streamlined experience with one point of contact for order placement and shipment arrangement

## Time saving

Eliminate the need to coordinate with multiple parties, saving valuable time and effort.

## Reliability

No warranty worries. Your products are protected as ordered from original factory.

## Cost Saving

Cut logistics costs by choosing all-inclusive service to ship all goods in one time

## IQC

- Material confirmation
- Material strength inspection
- Dimension measurement
- Color control
- Reliability check

## OQC

- Check all cartons well packed
- Professional goods loading
- Photo record for every shipment



## IPQC

- Detailed SOP in assembly process
- Exclusive-designed gauge
- First article inspection
- Check point setup

## FQC

- Full inspection for crucial function
- AQL final inspection
- Complete inspection report record

## Kelly, Your Best partner in Product development



- Over 20 years of resources and expertise in ergonomic OEM/ODM solutions
- One station service for integration in various materials and products
- Dedicated team for every **ODM/OEM** Project
- Prompt communications and quick reactions for every discussion
- Professional production suggestions for your products
- Quick and flexible manufacturing
- Knowledgeable with field applications

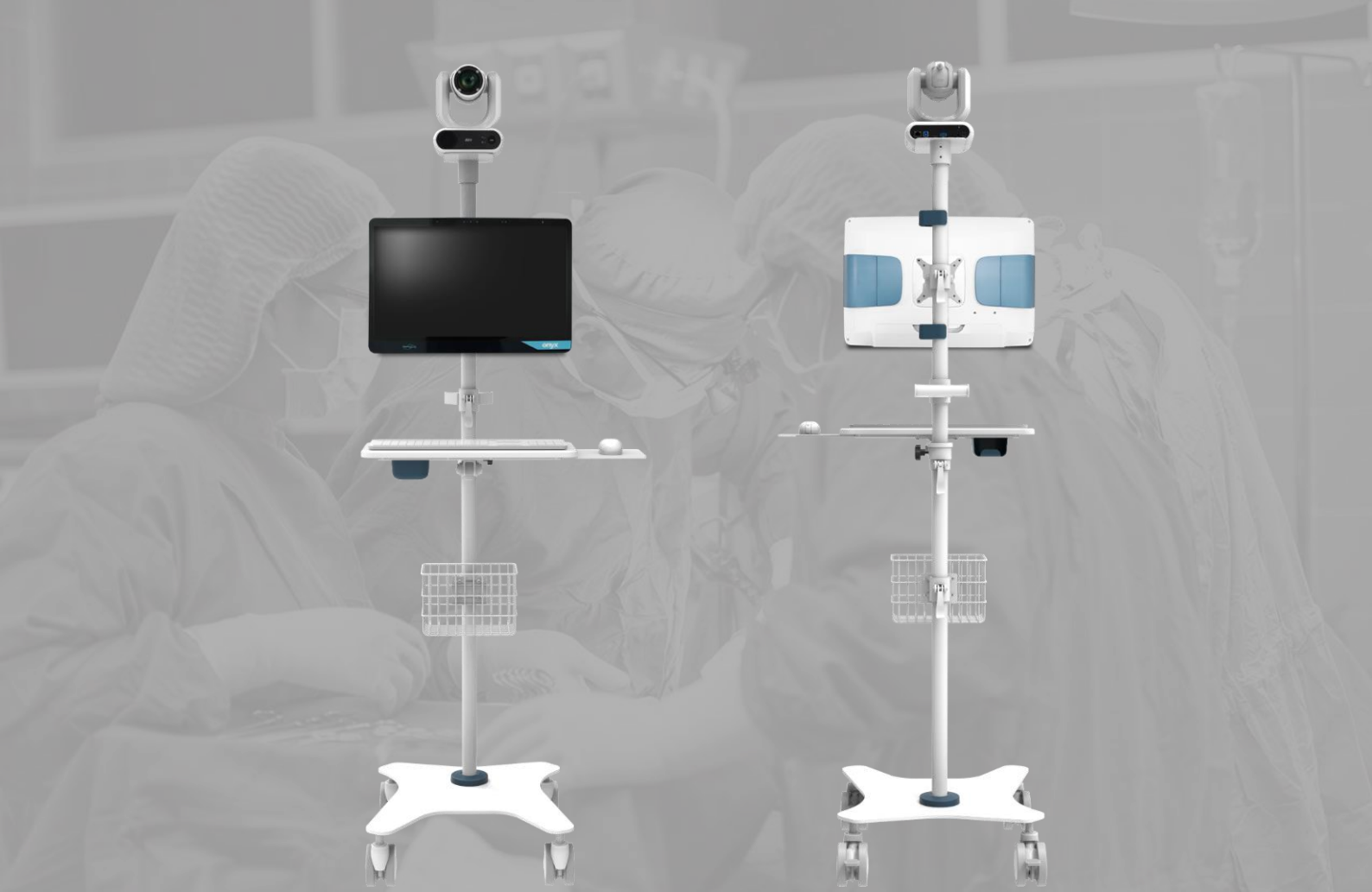

# Telehealth Solution



Medical cart



All-in-one  
Computer



PTZ camera

# Modular Medical Cart

KF-H-THC01

Easier integration of new features

Quicker troubleshooting

Scalability to meet changing demands.



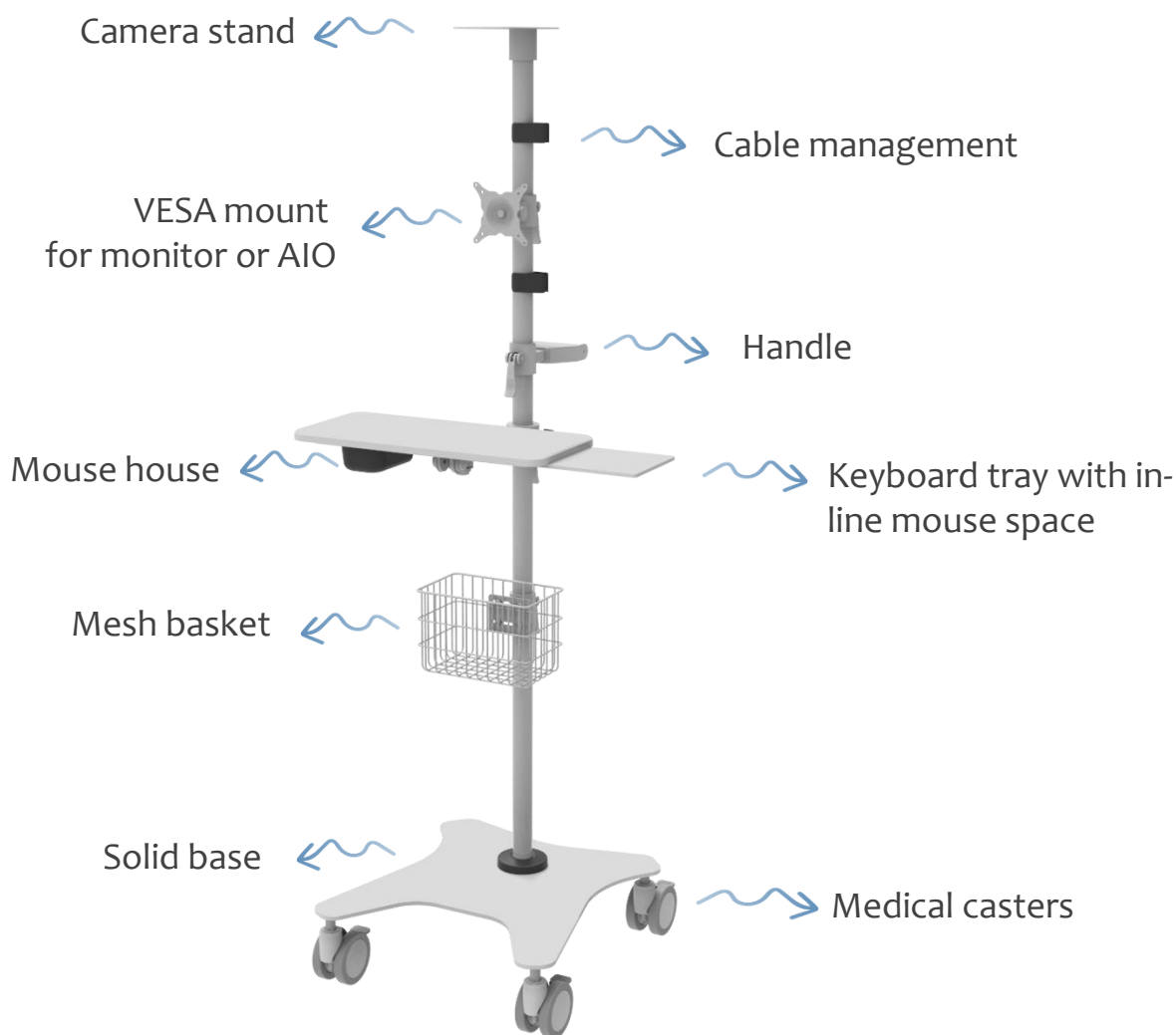

- Solid steel material for strong stability and high loading
- Premium workmanship
- Modular design for flexible design to fit different application
- Lockable Handle effortlessly elevate and secure at any height
- Ergonomic angle adjustment design
- Support nurse-patient connections, caregiver comfort and uptime by enabling efficient documentation at the point of care.



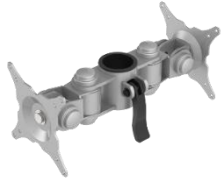



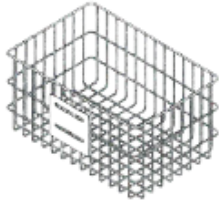
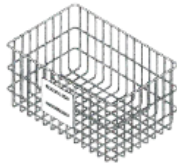

## Bracket

		
<p><b>Sing-U VESA head</b> Pan &amp; rotation function</p>	<p><b>Double U VESA head</b> Pan &amp; tilt &amp; rotation function</p>	<p><b>Back to back bracket</b> Pan &amp; tilt &amp; rotation function</p>

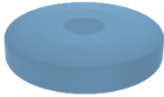
## Mesh basket

		
<p><b>KF-H-O2301</b> Large mesh basket 300x200x145mm</p>	<p><b>KF-H-O2302</b> Small mesh basket 240x150x160mm</p>	<p><b>KF-H-O2306</b> Large mesh basket with hooks 330x200x200mm</p>

## More

			
<p><b>Handle</b></p>	<p><b>Bumper for caster</b></p>	<p><b>Cable clip</b></p>	<p><b>CPU holder</b></p>
			
<p><b>Hot swat battery</b></p>	<p><b>Table top</b></p>	<p><b>Laptop tray</b></p>	<p><b>Probe holder</b></p>

# Medical All-in-One Computer

VENUS-224/244

Medical Grade IEC 60601-1-2

 **Windows 11**

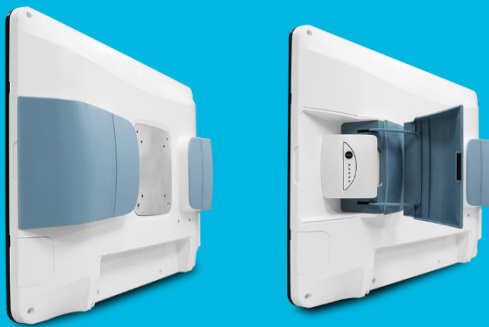

- Intel 11th gen Tigerlake, fan less implementation
- Windows 11 and IGEL Compliant
- Dual Hot Swap Batteries
- Easy cleanable and anti-bacterial
- Internal Imprivata compliant RFID reader (optional)
- WiFi 6 (optional)
- Compliant with all Venus batteries
- Remotely Manageable by central IT departments

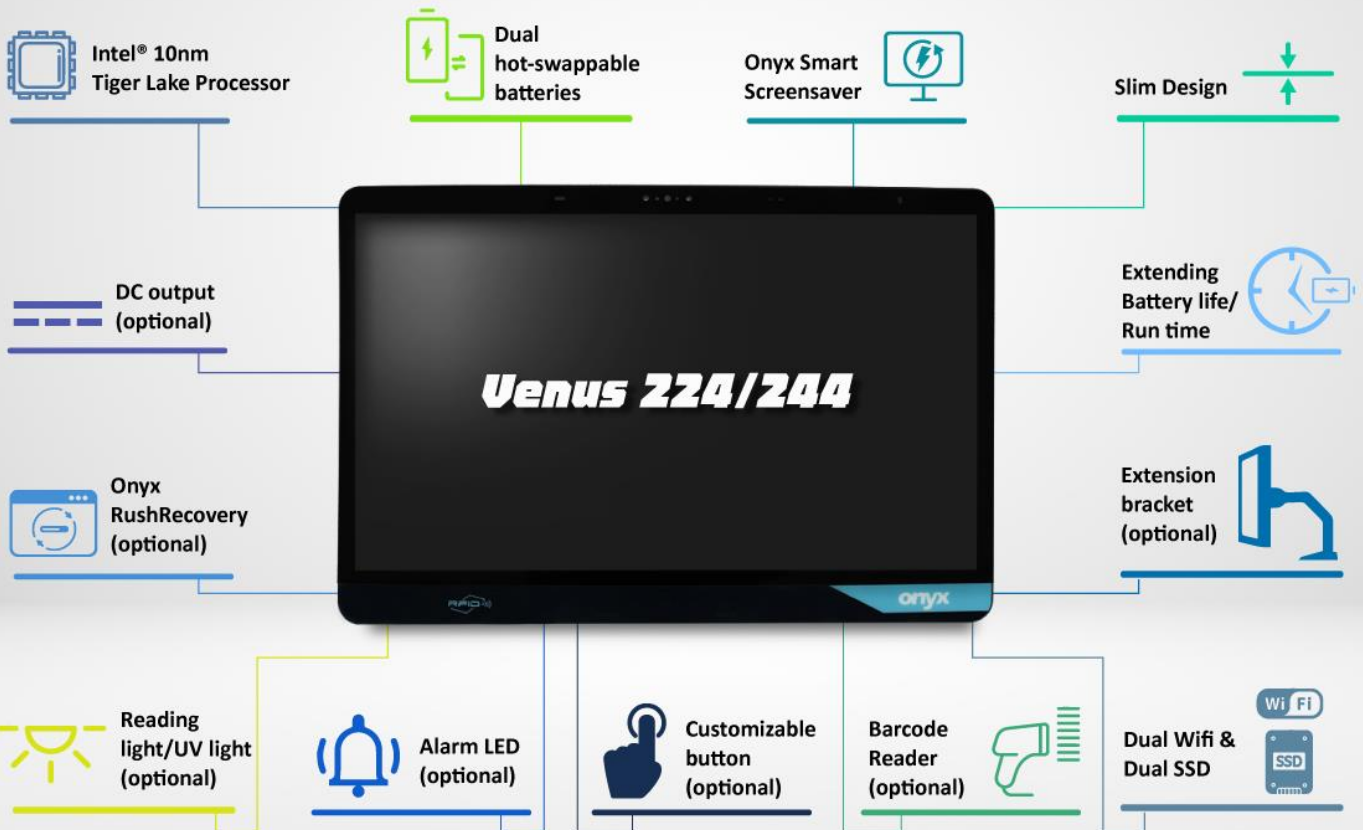



# Medical Grade PTZ Camera

MD330U/MD330UI  
Medical Grade IEC 60601-1-2



- 4K Output Resolution
- 30X optical zoom to see details in short working distance (1cm @1X)
- Smart AI – Face/Eye Tracking, Noise Reduction
- Local Privacy Mode & Mosaic Function
- Detachable Camera Head
- Embedded Speaker and Microphone
- One-Click to Control PTZ Functions
- One-Button Snapshot



MD330UI	MD330U	MD120UI
		
<ul style="list-style-type: none"> <li>• 30x IR Night View; 4k/30p</li> <li>• Build in speaker &amp; microphone</li> <li>• Detachable lens</li> </ul>	<ul style="list-style-type: none"> <li>• 30x LED Fill-light; 4k/30p</li> <li>• Build in speaker &amp; microphone</li> <li>• Detachable lens</li> </ul>	<ul style="list-style-type: none"> <li>• 20x IR Night View; 4k/60p</li> <li>• Build in Microphone</li> </ul>



MD330U/MD330UI  
Learn more



Pro AV Guarantee  
24 Hour Replacement | 3 Year Warranty

# Telemedicine



AVer MD330U integrated with Kinly's Med Offshore telemedicine solution (Photo by Valentinas Karpavicius)



- ✓ Mobility for flexible Telemedicine location
- ✓ Various accessory to accommodate different needs
- ✓ Enhanced clinical decision-making from distant locations
- ✓ Convenient Telemedicine appointments
- ✓ Efficiently save time, expenses, and resources
- ✓ Enhance patient consultations



# Telesitting



A Private Hospital in New Taipei City, Taiwan  
AVer Provides Connected Health Solutions and Elevates Patient Care through Tele-ICU

Source:

<https://communication.aver.com/Case-Study/tele-icu-solutions>



- ✓ Enhanced mobility for versatile telepresence
- ✓ Diverse accessories to cater to varied requirements
- ✓ Ideal for round-the-clock virtual patient surveillance
- ✓ Ensuring patient safety and reinforcing Healthcare staffing
- ✓ Empowering healthcare professionals with on-the-go patient data access

# Surgery Record & Broadcast

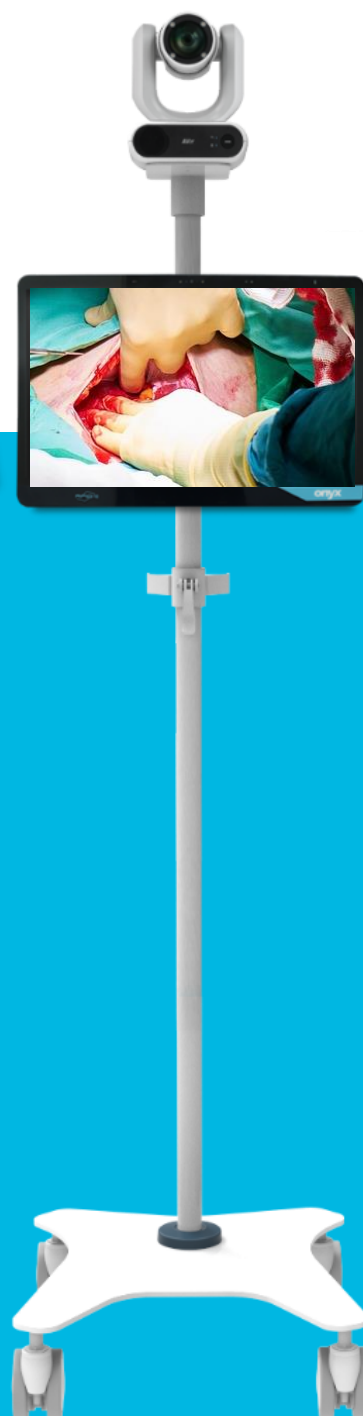

- ✓ Enhanced mobility for recording and broadcast function
- ✓ Diverse accessories to cater to varied requirements
- ✓ Maintaining accurate and detailed records of surgical procedures
- ✓ mitigate misunderstandings or disagreements between patients and healthcare providers
- ✓ Facilitate ongoing education and training for surgeons, nurses, and other staff members